

Article number: 12309000050100  
Description: KLEE-coil 309 000 050.100  
M5 Unhardened steel

## Measures

---

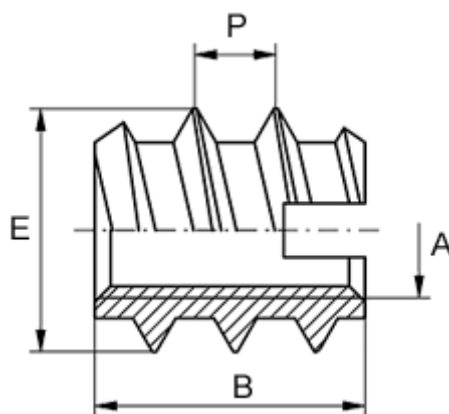

Female thread A	= M5
Length B	= 12
Male thread E	= 9.0
Min hole depth	= 15
Recommended bore diameter (plastic/hard wood)	= 6.7 to 6.9
Recommended bore diameter, soft wood (largest)	= 7.0
Thread pitch P	= 3.0